

3.2 EPIC® D A - V I N C I H - B

Gehäuse / Hood / Capot

Solide Bauform und ein umfangreiches Programm an passenden Einsätzen sind die markanten Merkmale dieses Gehäuses. Diese Bauform lässt sich aus dem Industriestandard nicht mehr wegdenken. Die Gehäuse der H-B Serie gibt es in sechs verschiedenen Gehäusegrößen.

The striking characteristics of these mount bases are a sturdy construction and a comprehensive range of corresponding inserts. This style is used in all industrial applications. The H-B series housings are available in six different sizes.

Une forme de construction solide et un programme important d'inserts adéquats sont les caractéristiques marquantes de ce boîtier. Cette forme de construction est devenue indispensable au standard industriel. Les boîtiers de la série H-B sont disponibles en six tailles différentes.

3

3.2 EPIC® D A - V I N C I H - B

Gehäuse / Hood / Capot



PG



M

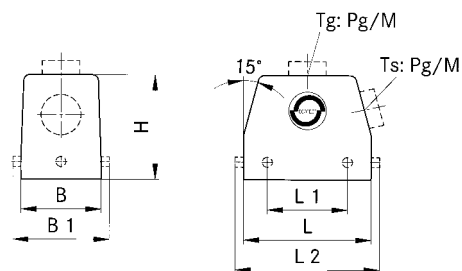

EPIC® H-B Gehäuse: Tüllengehäuse (Kabeleingang gerade, Bolzen für Längsbügel)

EPIC® H-B housings: hood (top entry, bolts for single locking lever)

Boîtiers EPIC® H-B: capot (sortie verticale, ergots pour simple levier)

H-B 6

Artikel part article	Art.Nr. part No. N° art.	PG	M	ZW	L	L1	L2	L3	L4	B	B1	B2	B3	B4	B5	H	H1	H2	S	d
H-B 6 TG 13,5	10011000	13,5		●	60		74,8			43				45		52				
H-B 6 TG 16	10021000	16		●																
H-B 6 TG M20	19011000		20		60		74,8			43										
H-B 6 TG M25	19021000		25																	

Einsätze / Inserts / Inserts: 1.4: H-BE 6 / 1.5: H-EE 10 / 1.9: H-DD 24 / 1.10: MC 6

Deckel / Cover / Couvercle: 6.1: H-BE 6

Kabelverschraubung / Cable gland / Presse-étoupe: 5.1: Metr. / 5.2: PG / 5.3: Kit

H-B 10

Artikel part article	Art.Nr. part No. N° art.	PG	M	ZW	L	L1	L2	L3	L4	B	B1	B2	B3	B4	B5	H	H1	H2	S	d
H-B 10 TG-RO 16	10040900	16		●	73		90			43				45		52				
H-B 10 TG-RO 21	10040700	21		●																
H-B 10 TG-RO M20	19040900		20		73		90			43				45		52				
H-B 10 TG-RO M25	19040700		25																	

Einsätze / Inserts / Inserts: 1.4: H-BE 10 / 1.5: H-EE 18 / 1.7: H-BVE 3 / 1.9: H-DD 42 / 1.10: MC 10

Kabelverschraubung / Cable gland / Presse-étoupe: 5.1: Metr. / 5.2: PG / 5.3: Kit



PG



M

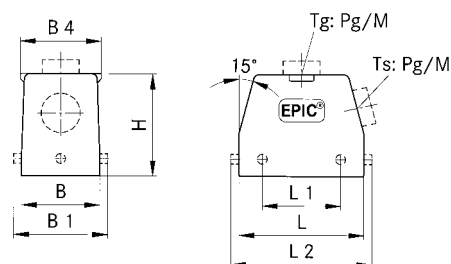

H-B 16

Artikel part article	Art.Nr. part No. N° art.	PG	M	ZW	L	L1	L2	L3	L4	B	B1	B2	B3	B4	B5	H	H1	H2	S	d
H-B 16 TG-RO 21	10080900	21		●	93,3		110			43						61				
H-B 16 TG-RO M25	19080900		25		93,3		110			43						61				

Einsätze / Inserts / Inserts: 1.4: H-BE 16 / 1.5: H-EE 32 / 1.6: H-BS 6 / 1.7: H-BVE 6 / 1.8: H-D 40 / 1.9: H-DD 72 / 1.10: MC 16

Kabelverschraubung / Cable gland / Presse-étoupe: 5.1: Metr. / 5.2: PG / 5.3: Kit

3.2 EPIC® D A - V I N C I H - B

Gehäuse / Hood / Capot



PG



M

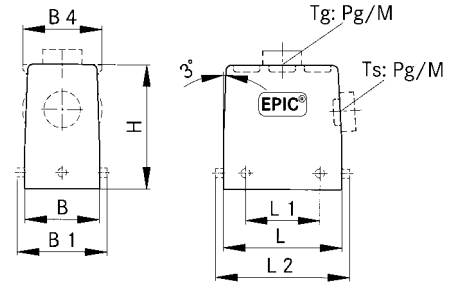

EPIC® H-B Gehäuse: Tüllengehäuse (Kabeleingang gerade, Bolzen für Längsbügel, hohe Bauform)

EPIC® H-B housings: hood (top entry, bolts for single locking lever, high version)

Boîtiers EPIC® H-B: capot (sortie verticale, ergots pour simple levier, version haute)

H-B 16

Artikel part article	Art.Nr. part No. N° art.	PG	M	ZW	L	L1	L2	L3	L4	B	B1	B2	B3	B4	B5	H	H1	H2	S	d
H-B 16 TGH-RO 21	70094200	21		●	93,3		110			43				45		76				
H-B 16 TGH-RO 29	70094400	29		●																
H-B 16 TGH-RO M25	79094200		25																	
H-B 16 TGH-RO M32	79094400		32		93,3		110			43				45		76				
H-B 16 TGH-RO M40	79094600		40																	

Einsätze / Inserts / Inserts: 1.4: H-BE 16 / 1.5: H-EE 32 / 1.6: H-BS 6 / 1.7: H-BVE 6 / 1.8: H-D 40 / 1.9: H-DD 72 / 1.10: MC 16
Kabelverschraubung / Cable gland / Presse-étoupe: 5.1: Metr. / 5.2: PG / 5.3: Kit

H-B 24

Artikel part article	Art.Nr. part No. N° art.	PG	M	ZW	L	L1	L2	L3	L4	B	B1	B2	B3	B4	B5	H	H1	H2	S	d
H-B 24 TGH-RO 21	70144400	21		●	120		137			43				45		76				
H-B 24 TGH-RO 29	70144600	29		●																
H-B 24 TGH-RO M25	79144400		25																	
H-B 24 TGH-RO M32	79144600		32		120		137			43				45		76				
H-B 24 TGH-RO M40	79144800		40																	

Einsätze / Inserts / Inserts: 1.4: H-BE 24 / 1.5: H-EE 46 / 1.7: H-BVE 10 / 1.8: H-D 64 / 1.9: H-DD 108 / 1.10: MC 24
Kabelverschraubung / Cable gland / Presse-étoupe: 5.1: Metr. / 5.2: PG / 5.3: Kit

3.2 EPIC® D A - V I N C I H - B

Gehäuse / Hood / Capot



PG / M

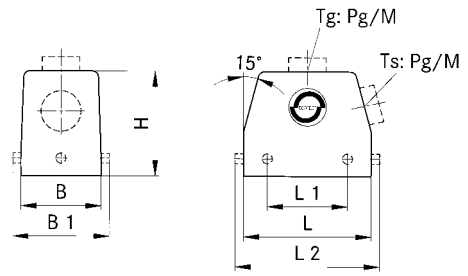

EPIC® H-B Gehäuse: Tüllengehäuse (Kabeleingang seitlich, Bolzen für Querbügel)

EPIC® H-B housings: hood (side entry, bolts for double locking lever)

Boîtiers EPIC® H-B: capot (sortie latérale, ergots pour double levier)

H-B 10

Artikel part article	Art.Nr. part No. N° art.	PG	M	ZW	L	L1	L2	L3	L4	B	B1	B2	B3	B4	B5	H	H1	H2	S	d
H-B 10 TS 16	10042000	16		●	73	27				43	57,8					52				
H-B 10 TS 21	10042100	21		●																
H-B 10 TS M20	19042000		20	●	73	27				43	57,8					52				
H-B 10 TS M25	19042100		25	●																

Einsätze / Inserts / Inserts: 1.4: H-BE 10 / 1.5: H-EE 18 / 1.7: H-BVE 3 / 1.9: H-DD 42 / 1.10: MC 10

Deckel / Cover / Couvercle: 6.1: H-B 10

Kabelverschraubung / Cable gland / Presse-étoupe: 5.1: Metr. / 5.2: PG / 5.3: Kit



PG / M

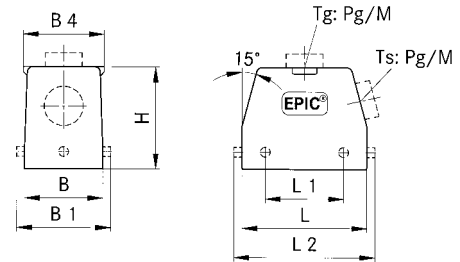

H-B 16

Artikel part article	Art.Nr. part No. N° art.	PG	M	ZW	L	L1	L2	L3	L4	B	B1	B2	B3	B4	B5	H	H1	H2	S	d
H-B 16 TS 21	10082000	21		●	93,3	47,5				43	57,8					61				
H-B 16 TS 29	10092000	29		●																
H-B 16 TS M25	19082000		25	●	93,3	47,5				43	57,8					61				
H-B 16 TS M32	19092000		32	●																

Einsätze / Inserts / Inserts: 1.4: H-BE 16 / 1.5: H-EE 32 / 1.6: H-BS 6 / 1.7: H-BVE 6 / 1.8: H-D 40 / 1.9: H-DD 72 / 1.10: MC 16

Deckel / Cover / Couvercle: 6.1: H-B 16

Kabelverschraubung / Cable gland / Presse-étoupe: 5.1: Metr. / 5.2: PG / 5.3: Kit

H-B 24

Artikel part article	Art.Nr. part No. N° art.	PG	M	ZW	L	L1	L2	L3	L4	B	B1	B2	B3	B4	B5	H	H1	H2	S	d
H-B 24 TS 21	10113000	21		●	120	74				43	57,8					61				
H-B 24 TS 29	10123000	29		●																
H-B 24 TS M25	19113000		25	●	120	74				43	57,8					61				
H-B 24 TS M32	19123000		32	●																

Einsätze / Inserts / Inserts: 1.4: H-BE 24 / 1.5: H-EE 46 / 1.7: H-BVE 10 / 1.8: H-D 64 / 1.9: H-DD 108 / 1.10: MC 24

Deckel / Cover / Couvercle: 6.1: H-B 24

Kabelverschraubung / Cable gland / Presse-étoupe: 5.1: Metr. / 5.2: PG / 5.3: Kit

3.2 EPIC® D A - V I N C I H - B

Gehäuse / Hood / Capot



PG



M

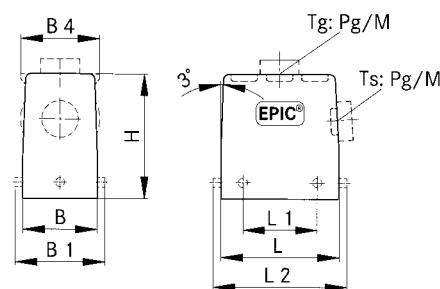

EPIC® H-B Gehäuse: Tüllengehäuse (Kabeleingang seitlich, Bolzen für Querbügel, hohe Bauform)
EPIC® H-B housings: hood (side entry, bolts for double locking lever, high version)
Boîtiers EPIC® H-B: capot (sortie latérale, ergots pour double levier, version haute)

H-B 10

Artikel part article	Art.Nr. part No. N° art.	PG	M	ZW	L	L1	L2	L3	L4	B	B1	B2	B3	B4	B5	H	H1	H2	S	d
H-B 10 TSH 21	70052400	21		●	73	27				43	57,8					72				
H-B 10 TSH 29	70052600	29		●																
H-B 10 TSH M25	79052400		25		73	27				43	57,8					72				
H-B 10 TSH M32	79052600		32																	

Einsätze / Inserts / Inserts: 1.4: H-BE 10 / 1.5: H-EE 18 / 1.7: H-BVE 3 / 1.9: H-DD 42 / 1.10: MC 10

Deckel / Cover / Couvercle: 6.1: H-B 10

Kabelverschraubung / Cable gland / Presse-étoupe: 5.1: Metr. / 5.2: PG / 5.3: Kit

H-B 16

Artikel part article	Art.Nr. part No. N° art.	PG	M	ZW	L	L1	L2	L3	L4	B	B1	B2	B3	B4	B5	H	H1	H2	S	d
H-B 16 TSH 21	70102200	21		●	93,3	47,5				43	57,8					76				
H-B 16 TSH 29	70102400	29		●																
H-B 16 TSH M25	79102200		25																	
H-B 16 TSH M32	79102400		32		93,3	47,5				43	57,8					76				
H-B 16 TSH M40	79102800		40																	

Einsätze / Inserts / Inserts: 1.4: H-BE 16 / 1.5: H-EE 32 / 1.6: H-BS 6 / 1.7: H-BVE 6 / 1.8: H-D 40 / 1.9: H-DD 72 / 1.10: MC 16

Deckel / Cover / Couvercle: 6.1: H-B 16

Kabelverschraubung / Cable gland / Presse-étoupe: 5.1: Metr. / 5.2: PG / 5.3: Kit

H-B 24

Artikel part article	Art.Nr. part No. N° art.	PG	M	ZW	L	L1	L2	L3	L4	B	B1	B2	B3	B4	B5	H	H1	H2	S	d
H-B 24 TSH 21	70152400	21		●	120	74				43	57,8					76				
H-B 24 TSH 29	70152600	29		●																
H-B 24 TSH M25	79152400		25																	
H-B 24 TSH M32	79152600		32		120	74				43	57,8					76				
H-B 24 TSH M40	79152800		40																	

Einsätze / Inserts / Inserts: 1.4: H-BE 24 / 1.5: H-EE 46 / 1.7: H-BVE 10 / 1.8: H-D 64 / 1.9: H-DD 108 / 1.10: MC 24

Deckel / Cover / Couvercle: 6.1: H-B 24

Kabelverschraubung / Cable gland / Presse-étoupe: 5.1: Metr. / 5.2: PG / 5.3: Kit

3.2 EPIC® D A - V I N C I H - B

Gehäuse / Hood / Capot



PG / M

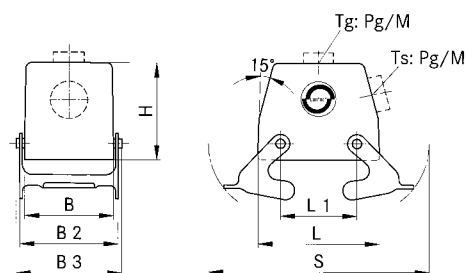

EPIC® H-B Gehäuse: Tüllengehäuse (Kabeleingang seitlich, Querbügel)

EPIC® H-B housings: hood (side entry, double locking lever)

Boîtiers EPIC® H-B: capot (sortie latérale, double levier)

H-B 10

Artikel part article	Art.Nr. part No. N° art.	PG	M	ZW	L	L1	L2	L3	L4	B	B1	B2	B3	B4	B5	H	H1	H2	S	d
H-B 10 TSB 16	10045000	16		●	73	27				43	57,8	53				52				116
H-B 10 TSB M20	19045000		20	●	73	27				43	57,8	53				52				116
H-B 10 TSB M25	79057700		25	●																

Einsätze / Inserts / Inserts: 1.4: H-BE 10 / 1.5: H-EE 18 / 1.7: H-BVE 3 / 1.9: H-DD 42 / 1.10: MC 10

Deckel / Cover / Couvercle: 6.1: H-B 10

Kabelverschraubung / Cable gland / Presse-étoupe: 5.1: Metr. / 5.2: PG / 5.3: Kit



PG / M

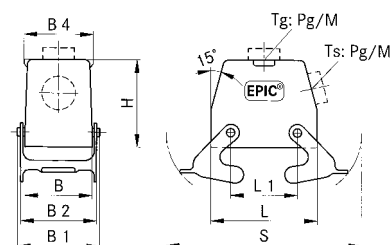

H-B 16

Artikel part article	Art.Nr. part No. N° art.	PG	M	ZW	L	L1	L2	L3	L4	B	B1	B2	B3	B4	B5	H	H1	H2	S	d
H-B 16 TSB 21	10083000	21		●	93,3	47,5				43	57,8	53				61				136,5
H-B 16 TSB M25	19083000		25	●	93,3	47,5				43	57,8	53				61				136,5

Einsätze / Inserts / Inserts: 1.4: H-BE 16 / 1.5: H-EE 32 / 1.6: H-BS 6 / 1.7: H-BVE 6 / 1.8: H-D 40 / 1.9: H-DD 72 / 1.10: MC 16

Deckel / Cover / Couvercle: 6.1: H-B 16

Kabelverschraubung / Cable gland / Presse-étoupe: 5.1: Metr. / 5.2: PG / 5.3: Kit

H-B 24

Artikel part article	Art.Nr. part No. N° art.	PG	M	ZW	L	L1	L2	L3	L4	B	B1	B2	B3	B4	B5	H	H1	H2	S	d
H-B 24 TSB 21	10114000	21		●	120	74				43	57,8	53				61				163
H-B 24 TSB 29	10124000	29		●																
H-B 24 TSB M25	19114000		25	●	120	74				43	57,8	53				61				163
H-B 24 TSB M32	19124000		32	●																

Einsätze / Inserts / Inserts: 1.4: H-BE 24 / 1.5: H-EE 46 / 1.7: H-BVE 10 / 1.8: H-D 64 / 1.9: H-DD 108 / 1.10: MC 24

Deckel / Cover / Couvercle: 6.1: H-B 24

Kabelverschraubung / Cable gland / Presse-étoupe: 5.1: Metr. / 5.2: PG / 5.3: Kit

3.2 EPIC® D A - V I N C I H - B

Gehäuse / Hood / Capot



PG



M

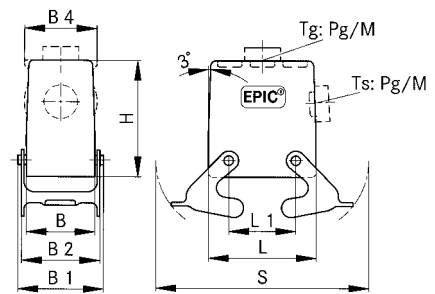

EPIC® H-B Gehäuse: Tüllengehäuse (Kabeleingang seitlich, Querbügel, hohe Bauform)

EPIC® H-B housings: hood (side entry, double locking lever, high version)

Boîtiers EPIC® H-B: capot (sortie latérale, double levier, version haute)

H-B 10

Artikel part article	Art.Nr. part No. N° art.	PG	M	ZW	L	L1	L2	L3	L4	B	B1	B2	B3	B4	B5	H	H1	H2	S	d
H-B 10 TSBH 21	70057200	21		●	73	27				43	57,8	53				72				116
H-B 10 TSBH 29	70057400	29		●																
H-B 10 TSBH M25	79057200		25		73	27				43	57,8	53				72				116
H-B 10 TSBH M32	79057400		32																	

Einsätze / Inserts / Inserts: 1.4: H-BE 10 / 1.5: H-EE 18 / 1.7: H-BVE 3 / 1.9: H-DD 42 / 1.10: MC 10

Deckel / Cover / Couvercle: 6.1: H-B 10

Kabelverschraubung / Cable gland / Presse-étoupe: 5.1: Metr. / 5.2: PG / 5.3: Kit

H-B 16

Artikel part article	Art.Nr. part No. N° art.	PG	M	ZW	L	L1	L2	L3	L4	B	B1	B2	B3	B4	B5	H	H1	H2	S	d
H-B 16 TSBH 21	70107200	21		●	93,3	47,5				43	57,8	53				76				136,5
H-B 16 TSBH 29	70107400	29		●																
H-B 16 TSBH M25	79107200		25		93,3	47,5				43	57,8	53				76				136,5
H-B 16 TSBH M32	79107400		32																	

Einsätze / Inserts / Inserts: 1.4: H-BE 16 / 1.5: H-EE 32 / 1.6: H-BS 6 / 1.7: H-BVE 6 / 1.8: H-D 40 / 1.9: H-DD 72 / 1.10: MC 16

Deckel / Cover / Couvercle: 6.1: H-B 16

Kabelverschraubung / Cable gland / Presse-étoupe: 5.1: Metr. / 5.2: PG / 5.3: Kit

H-B 24

Artikel part article	Art.Nr. part No. N° art.	PG	M	ZW	L	L1	L2	L3	L4	B	B1	B2	B3	B4	B5	H	H1	H2	S	d
H-B 24 TSBH 21	70157400	21		●	120	74				43	57,8	53				76				163
H-B 24 TSBH 29	70157600	29		●																
H-B 24 TSBH M25	79157400		25		120	74				43	57,8	53				76				163
H-B 24 TSBH M32	79157600		32																	

Einsätze / Inserts / Inserts: 1.4: H-BE 24 / 1.5: H-EE 46 / 1.7: H-BVE 10 / 1.8: H-D 64 / 1.9: H-DD 108 / 1.10: MC 24

Deckel / Cover / Couvercle: 6.1: H-B 24

Kabelverschraubung / Cable gland / Presse-étoupe: 5.1: Metr. / 5.2: PG / 5.3: Kit

3.2 EPIC® D A - V I N C I H - B

Gehäuse / Hood / Capot



PG / M

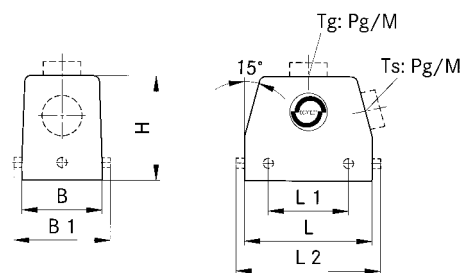

EPIC® H-B Gehäuse: Tüllengehäuse (Kabeleingang seitlich, Bolzen für Längsbügel)

EPIC® H-B housings: hood (side entry, bolts for single locking lever)

Boîtiers EPIC® H-B: capot (sortie latérale, ergots pour simple levier)

H-B 6

Artikel part article	Art.Nr. part No. N° art.	PG	M	ZW	L	L1	L2	L3	L4	B	B1	B2	B3	B4	B5	H	H1	H2	S	d
H-B 6 TS 13,5	10012000	13,5		●	60		74,8			43						52				
H-B 6 TS 16	10022000	16		●																
H-B 6 TS M20	19012000		20	●	60		74,8			43						52				
H-B 6 TS M25	19022000		25	●																

Einsätze / Inserts / Inserts: 1.4: H-BE 6 / 1.5: H-EE 10 / 1.9: H-DD 24 / 1.10: MC 6

Deckel / Cover / Couvercle: 6.1: H-B 6

Kabelverschraubung / Cable gland / Presse-étoupe: 5.1: Metr. / 5.2: PG / 5.3: Kit

H-B 10

Artikel part article	Art.Nr. part No. N° art.	PG	M	L	L1	L2	L3	L4	B	B1	B2	B3	B4	B5	H	H1	H2	S	d	
H-B 10 TS-RO 16	10042900		16		73	90			43							52				
H-B 10 TS-RO 21	10042800		21																	
H-B 10 TS-RO M20	19042900			20	73	90			43							52				
H-B 10 TS-RO M25	19042800			25																

Einsätze / Inserts / Inserts: 1.4: H-BE 10 / 1.5: H-EE 18 / 1.7: H-BVE 3 / 1.9: H-DD 42 / 1.10: MC 10

Kabelverschraubung / Cable gland / Presse-étoupe: 5.1: Metr. / 5.2: PG / 5.3: Kit



PG / M

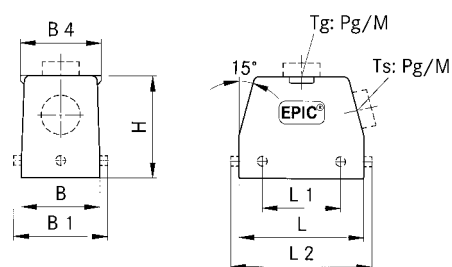

H-B 16

Artikel part article	Art.Nr. part No. N° art.	PG	M	ZW	L	L1	L2	L3	L4	B	B1	B2	B3	B4	B5	H	H1	H2	S	d
H-B 16 TS-RO 21	10082900		21	●		93,3	110			43				45		61				
H-B 16 TS-RO 29	10092900		29	●																
H-B 16 TS-RO M25	19082900			25	●	93,3	110			43				45		61				
H-B 16 TS-RO M32	19092900			32	●															

Einsätze / Inserts / Inserts: 1.4: H-BE 16 / 1.5: H-EE 32 / 1.6: H-BS 6 / 1.7: H-BVE 6 / 1.8: H-D 40 / 1.9: H-DD 72 / 1.10: MC 16

Kabelverschraubung / Cable gland / Presse-étoupe: 5.1: Metr. / 5.2: PG / 5.3: Kit

3.2 EPIC® D A - V I N C I H - B

Gehäuse / Hood / Capot



PG



M

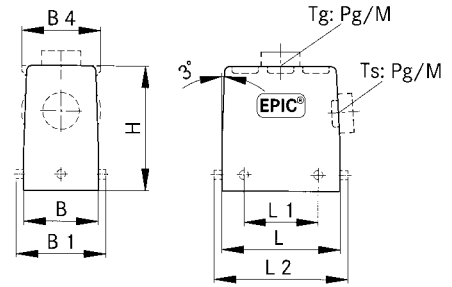

EPIC® H-B Gehäuse: Tüllengehäuse (Kabeleingang seitlich, Bolzen für Längsbügel, hohe Bauform)

EPIC® H-B housings: hood (side entry, bolts for single locking lever, high version)

Boîtiers EPIC® H-B: capot (sortie latérale, ergots pour simple levier, version haute)

H-B 6

Artikel part article	Art.Nr. part No. N° art.	PG	M	ZW	L	L1	L2	L3	L4	B	B1	B2	B3	B4	B5	H	H1	H2	S	d
H-B 6 TSH 21	70022200	21		●	60		74,8			43					45		72			
H-B 6 TSH 29	70022400	29		●	60		74,8			43					45		72			
H-B 6 TSH M25	79022200		25		60		74,8			43					45		72			
H-B 6 TSH M32	79022400		32		60		74,8			43					45		72			

Einsätze / Inserts / Inserts: 1.4: H-BE 6 / 1.5: H-EE 10 / 1.9: H-DD 24 / 1.10: MC 6

Deckel / Cover / Couvercle: 6.1: H-B 6

Kabelverschraubung / Cable gland / Presse-étoupe: 5.1: Metr. / 5.2: PG / 5.3: Kit

H-B 10

Artikel part article	Art.Nr. part No. N° art.	PG	M	ZW	L	L1	L2	L3	L4	B	B1	B2	B3	B4	B5	H	H1	H2	S	d
H-B 10 TSH-RO 21	70054200	21		●	73		90			43					45		72			
H-B 10 TSH-RO 29	70054400	29		●	73		90			43					45		72			
H-B 10 TSH-RO M25	79054200		25		73		90			43					45		72			
H-B 10 TSH-RO M32	79054400		32		73		90			43					45		72			

Einsätze / Inserts / Inserts: 1.4: H-BE 10 / 1.5: H-EE 10 / 1.7: H-BVE 3 / 1.9: H-DD 42 / 1.10: MC 10

Kabelverschraubung / Cable gland / Presse-étoupe: 5.1: Metr. / 5.2: PG / 5.3: Kit

H-B 16

Artikel part article	Art.Nr. part No. N° art.	PG	M	ZW	L	L1	L2	L3	L4	B	B1	B2	B3	B4	B5	H	H1	H2	S	d
H-B 16 TSH-RO 21	70104200	21		●	93,3		110			43					45		76			
H-B 16 TSH-RO 29	70104400	29		●	93,3		110			43					45		76			
H-B 16 TSH-RO M25	79104200		25		93,3		110			43					45		76			
H-B 16 TSH-RO M32	79104400		32		93,3		110			43					45		76			
H-B 16 TSH-RO M40	79104800		40		93,3		110			43					45		76			

Einsätze / Inserts / Inserts: 1.4: H-BE 16 / 1.5: H-EE 32 / 1.6: H-BS 6 / 1.7: H-BVE 6 / 1.8: H-D 40 / 1.9: H-DD 72 / 1.10: MC 16

Kabelverschraubung / Cable gland / Presse-étoupe: 5.1: Metr. / 5.2: PG / 5.3: Kit

H-B 24

Artikel part article	Art.Nr. part No. N° art.	PG	M	ZW	L	L1	L2	L3	L4	B	B1	B2	B3	B4	B5	H	H1	H2	S	d
H-B 24 TSH-RO 21	70154400	21		●	120		137			43					45		76			
H-B 24 TSH-RO 29	70154600	29		●	120		137			43					45		76			
H-B 24 TSH-RO M25	79154400		25		120		137			43					45		76			
H-B 24 TSH-RO M32	79154600		32		120		137			43					45		76			
H-B 24 TSH-RO M40	79154800		40		120		137			43					45		76			

Einsätze / Inserts / Inserts: 1.4: H-BE 24 / 1.5: H-EE 46 / 1.7: H-BVE 10 / 1.8: H-D 64 / 1.9: H-DD 108 / 1.10: MC 24

Kabelverschraubung / Cable gland / Presse-étoupe: 5.1: Metr. / 5.2: PG / 5.3: Kit

3.2 EPIC® D A - V I N C I H - B

Gehäuse / Hood / Capot



PG



M

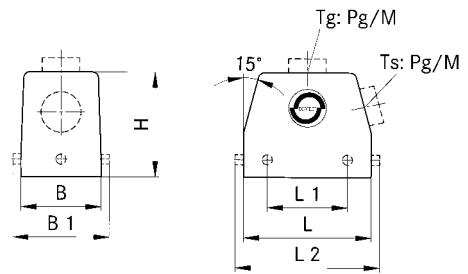

EPIC® H-B Gehäuse: Tüllengehäuse (Kabeleingang gerade, Bolzen für Querbügel)

EPIC® H-B housings: hood (top entry, bolts for double locking lever)

Boîtiers EPIC® H-B: capot (sortie verticale, ergots pour double levier)

H-B 10

Artikel part article	Art.Nr. part No. N° art.	PG	M	ZW	L	L1	L2	L3	L4	B	B1	B2	B3	B4	B5	H	H1	H2	S	d
H-B 10 TG 16	10040000	16		●	73	27				43	57,8			45		52				
H-B 10 TG 21	10040100	21		●																
H-B 10 TG M20	19040000		20		73	27				43	57,8			45		52				
H-B 10 TG M25	19040100		25																	

Einsätze / Inserts / Inserts: 1.4: H-BE 10 / 1.5: H-EE 18 / 1.7: H-BVE 3 / 1.9: H-DD 42 / 1.10: MC 10

Deckel / Cover / Couvercle: 6.1: H-B 10

Kabelverschraubung / Cable gland / Presse-étoupe: 5.1: Metr. / 5.2: PG / 5.3: Kit



PG



M

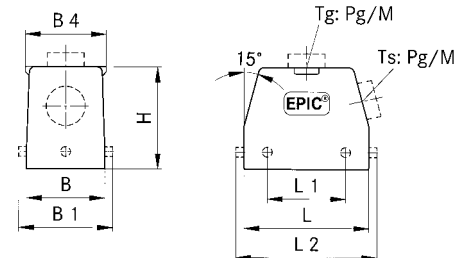

H-B 16

Artikel part article	Art.Nr. part No. N° art.	PG	M	ZW	L	L1	L2	L3	L4	B	B1	B2	B3	B4	B5	H	H1	H2	S	d
H-B 16 TG 21	10080000	21		●	93,3	47,5				43	57,8			45		61				
H-B 16 TG 29	10090000	29		●																
H-B 16 TG M25	19080000		25		93,3	47,5				43	57,8			45		61				
H-B 16 TG M32	19090000		32																	

Einsätze / Inserts / Inserts: 1.4: H-BE 16 / 1.5: H-EE 32 / 1.6: H-BS 6 / 1.7: H-BVE 6 / 1.8: H-D 40 / 1.9: H-DD 72 / 1.10: MC 16

Deckel / Cover / Couvercle: 6.1: H-B 16

Kabelverschraubung / Cable gland / Presse-étoupe: 5.1: Metr. / 5.2: PG / 5.3: Kit

H-B 24

Artikel part article	Art.Nr. part No. N° art.	PG	M	ZW	L	L1	L2	L3	L4	B	B1	B2	B3	B4	B5	H	H1	H2	S	d
H-B 24 TG 21	10121000	21		●	120	74				43	57,8			45		61				
H-B 24 TG 29	10111000	29		●																
H-B 24 TG M25	19121000		25		120	74				43	57,8			45		61				
H-B 24 TG M32	19111000		32																	

Einsätze / Inserts / Inserts: 1.4: H-BE 24 / 1.5: H-EE 46 / 1.7: H-BVE 10 / 1.8: H-D 64 / 1.9: H-DD 108 / 1.10: MC 24

Deckel / Cover / Couvercle: 6.1: H-B 24

Kabelverschraubung / Cable gland / Presse-étoupe: 5.1: Metr. / 5.2: PG / 5.3: Kit

3.2 EPIC® D A - V I N C I H - B

Gehäuse / Hood / Capot



PG



M

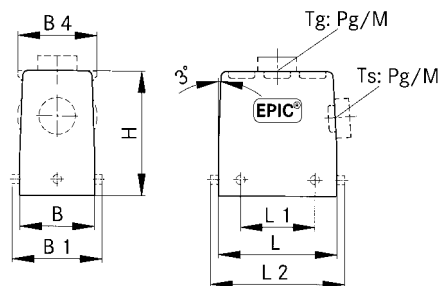

EPIC® H-B Gehäuse: Tüllengehäuse (Kabeleingang gerade, Bolzen für Querbügel, hohe Bauform)
EPIC® H-B housings: hood (top entry, bolts for double locking lever, high version)
Boîtiers EPIC® H-B: capot (sortie verticale, ergots pour double levier, version haute)

H-B 10

Artikel part article	Art.Nr. part No. N° art.	PG	M	ZW	L	L1	L2	L3	L4	B	B1	B2	B3	B4	B5	H	H1	H2	S	d
H-B 10 TGH 21	70050400	21		●	73	27				43	57,8			45		72				
H-B 10 TGH 29	70050600	29		●																
H-B 10 TGH M25	79050400		25		73	27				43	57,8			45		72				
H-B 10 TGH M32	79050600		32																	

Einsätze / Inserts / Inserts: 1.4: H-BE 10 / 1.5: H-EE 18 / 1.7: H-BVE 3 / 1.9: H-DD 42 / 1.10: MC 10

Deckel / Cover / Couvercle: 6.1: H-B 10

Kabelverschraubung / Cable gland / Presse-étoupe: 5.1: Metr. / 5.2: PG / 5.3: Kit

H-B 16

Artikel part article	Art.Nr. part No. N° art.	PG	M	ZW	L	L1	L2	L3	L4	B	B1	B2	B3	B4	B5	H	H1	H2	S	d
H-B 16 TGH 21	70100200	21		●	93,3	47,5				43	57,8			45		76				
H-B 16 TGH 29	70100400	29		●																
H-B 16 TGH M25	79100200		25																	
H-B 16 TGH M32	79100400		32		93,3	47,5				43	57,8			45		76				
H-B 16 TGH M40	79100800		40																	

Einsätze / Inserts / Inserts: 1.4: H-BE 16 / 1.5: H-EE 32 / 1.6: H-BS 6 / 1.7: H-BVE 6 / 1.8: H-D 40 / 1.9: H-DD 72 / 1.10: MC 16

Deckel / Cover / Couvercle: 6.1: H-B 16

Kabelverschraubung / Cable gland / Presse-étoupe: 5.1: Metr. / 5.2: PG / 5.3: Kit

H-B 24

Artikel part article	Art.Nr. part No. N° art.	PG	M	ZW	L	L1	L2	L3	L4	B	B1	B2	B3	B4	B5	H	H1	H2	S	d
H-B 24 TGH 21	70150400	21		●	120	74				43	57,8			45		76				
H-B 24 TGH 29	70150600	29		●																
H-B 24 TGH M25	79150400		25																	
H-B 24 TGH M32	79150600		32		120	74				43	57,8			45		76				
H-B 24 TGH M40	79150800		40																	

Einsätze / Inserts / Inserts: 1.4: H-BE 24 / 1.5: H-EE 46 / 1.7: H-BVE 10 / 1.8: H-D 64 / 1.9: H-DD 108 / 1.10: MC 24

Deckel / Cover / Couvercle: 6.1: H-B 24

Kabelverschraubung / Cable gland / Presse-étoupe: 5.1: Metr. / 5.2: PG / 5.3: Kit

3.2 EPIC® D A - V I N C I H - B

Gehäuse / Hood / Capot



PG



M

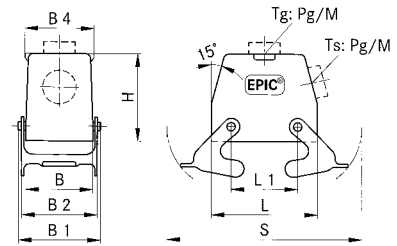

EPIC® H-B Gehäuse: Tüllengehäuse (Kabeleingang gerade, Querbügel)

EPIC® H-B housings: hood (top entry, double locking lever)

Boîtiers EPIC® H-B: capot (sortie verticale, double levier)

H-B 16

Artikel part article	Art.Nr. part No. N° art.	PG	M	ZW	L	L1	L2	L3	L4	B	B1	B2	B3	B4	B5	H	H1	H2	S	d
H-B 16 TGB 21	10081000	21		●	93,3	47,5				43	57,8	53				61				136,5
H-B 16 TGB M25	19081000		25		93,3	47,5				43	57,8	53				61				136,5

Einsätze / Inserts / Inserts: 1.4: H-BE 16 / 1.5: H-EE 32 / 1.6: H-BS 6 / 1.7: H-BVE 6 / 1.8: H-D 40 / 1.9: H-DD 72 / 1.10: MC 16

Deckel / Cover / Couvercle: 6.1: H-B 16

Kabelverschraubung / Cable gland / Presse-étoupe: 5.1: Metr. / 5.2: PG / 5.3: Kit

H-B 24

Artikel part article	Art.Nr. part No. N° art.	PG	M	ZW	L	L1	L2	L3	L4	B	B1	B2	B3	B4	B5	H	H1	H2	S	d
H-B 24 TGB 21	10122000	21		●	120	74				43	57,8	53				61				163
H-B 24 TGB 29	10112000	29		●																
H-B 24 TGB M25	19122000		25		120	74				43	57,8	53				61				163
H-B 24 TGB M32	19112000		32																	

Einsätze / Inserts / Inserts: 1.4: H-BE 24 / 1.5: H-EE 46 / 1.7: H-BVE 10 / 1.8: H-D 64 / 1.9: H-DD 108 / 1.10: MC 24

Deckel / Cover / Couvercle: 6.1: H-B 24

Kabelverschraubung / Cable gland / Presse-étoupe: 5.1: Metr. / 5.2: PG / 5.3: Kit

3.2 EPIC® D A - V I N C I H - B

Gehäuse / Hood / Capot



PG



M

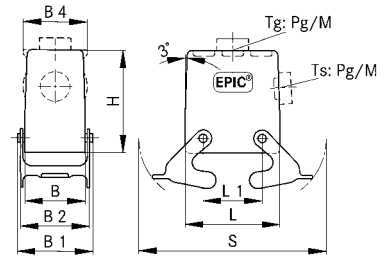

EPIC® H-B Gehäuse: Tüllengehäuse (Kabeleingang gerade, Querbügel, hohe Bauform)

EPIC® H-B housings: hood (top entry, double locking lever, high version)

Boîtiers EPIC® H-B: capot (sortie verticale, double levier, version haute)

H-B 10

Artikel part article	Art.Nr. part No. N° art.	PG	M	ZW	L	L1	L2	L3	L4	B	B1	B2	B3	B4	B5	H	H1	H2	S	d
H-B 10 TGBH 21	70055200	21		●	73	27				43	57,8	53				72				116
H-B 10 TGBH 29	70055400	29		●																
H-B 10 TGBH M25	79055200		25		73	27				43	57,8	53				72				116
H-B 10 TGBH M32	79055400		32																	

Einsätze / Inserts / Inserts: 1.4: H-BE 10 / 1.5: H-EE 18 / 1.7: H-BVE 3 / 1.9: H-DD 42 / 1.10: MC 10

Deckel / Cover / Couvercle: 6.1: H-B 10

Kabelverschraubung / Cable gland / Presse-étoupe: 5.1: Metr. / 5.2: PG / 5.3: Kit

H-B 16

Artikel part article	Art.Nr. part No. N° art.	PG	M	ZW	L	L1	L2	L3	L4	B	B1	B2	B3	B4	B5	H	H1	H2	S	d
H-B 16 TGBH 21	70105200	21		●	93,3	47,5				43	57,8	53				76				136,5
H-B 16 TGBH 29	70105400	29		●																
H-B 16 TGBH M25	79105200		25		93,3	47,5				43	57,8	53				76				136,5
H-B 16 TGBH M32	79105400		32																	

Einsätze / Inserts / Inserts: 1.4: H-BE 16 / 1.5: H-EE 32 / 1.6: H-BS 6 / 1.7: H-BVE 6 / 1.8: H-D 40 / 1.9: H-DD 72 / 1.10: MC 16

Deckel / Cover / Couvercle: 6.1: H-B 16

Kabelverschraubung / Cable gland / Presse-étoupe: 5.1: Metr. / 5.2: PG / 5.3: Kit

H-B 24

Artikel part article	Art.Nr. part No. N° art.	PG	M	ZW	L	L1	L2	L3	L4	B	B1	B2	B3	B4	B5	H	H1	H2	S	d
H-B 24 TGBH 21	70155400	21		●	120	74				43	57,8	53				76				163
H-B 24 TGBH 29	70155600	29		●																
H-B 24 TGBH M25	79155400		25		120	74				43	57,8	53				76				163
H-B 24 TGBH M32	79155600		32																	

Einsätze / Inserts / Inserts: 1.4: H-BE 24 / 1.5: H-EE 46 / 1.7: H-BVE 10 / 1.8: H-D 64 / 1.9: H-DD 108 / 1.10: MC 24

Deckel / Cover / Couvercle: 6.1: H-B 24

Kabelverschraubung / Cable gland / Presse-étoupe: 5.1: Metr. / 5.2: PG / 5.3: Kit

3.2 EPIC® D A - V I N C I H - B

Gehäuse / Hood / Capot



PG



M

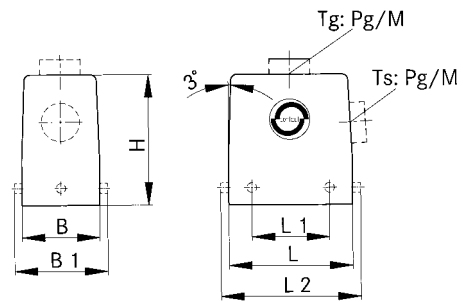

EPIC® H-B Gehäuse: Tüllengehäuse (Kabeleingang gerade, Bolzen für Querbügel)

EPIC® H-B housings: hood (top entry, bolts for double locking lever)

Boîtiers EPIC® H-B: capot (sortie verticale, ergots pour double levier)

H-B 32

Artikel part article	Art.Nr. part No. N° art.	PG	M	ZW	L	L1	L2	L3	L4	B	B1	B2	B3	B4	B5	H	H1	H2	S	d
H-B 32 TG 21	10133000	21		●	93,5	64,5				79	89,5					95				
H-B 32 TG 29	10134000	29		●																
H-B 32 TG M32	19134000		32		93,5	64,5				79	89,5					95				
H-B 32 TG M40	19134400		40																	

Einsätze / Inserts / Inserts: 1.4: H-BE 32 / 1.5: H-EE 64 / 1.6: H-BS 12 / 1.8: H-D 80 / 1.9: H-DD 144 / 1.10: 2 x MC 16

Kabelverschraubung / Cable gland / Presse-étoupe: 5.1: Metr. / 5.2: PG / 5.3: Kit



PG



M

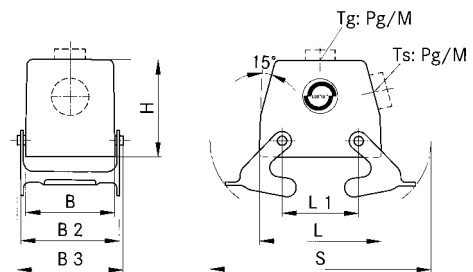

EPIC® H-B Gehäuse: Tüllengehäuse (Kabeleingang gerade, Querbügel)

EPIC® H-B housings: hood (top entry, double locking lever)

Boîtiers EPIC® H-B: capot (sortie verticale, double levier)

H-B 10

Artikel part article	Art.Nr. part No. N° art.	PG	M	ZW	L	L1	L2	L3	L4	B	B1	B2	B3	B4	B5	H	H1	H2	S	d
H-B 10 TGB 16	10041000	16		●	73	27				43	57,8	53				52				116
H-B 10 TGB M20	19041000		20		73	27				43	57,8	53				52				116
H-B 10 TGB M25	79055700		25																	

Einsätze / Inserts / Inserts: 1.4: H-BE 10 / 1.5: H-EE 18 / 1.7: H-BVE 3 / 1.9: H-DD 42 / 1.10: MC 10

Deckel / Cover / Couvercle: 6.1: H-B 10

Kabelverschraubung / Cable gland / Presse-étoupe: 5.1: Metr. / 5.2: PG / 5.3: Kit

3.2 EPIC® D A - V I N C I H - B

Gehäuse / Hood / Capot



PG



M

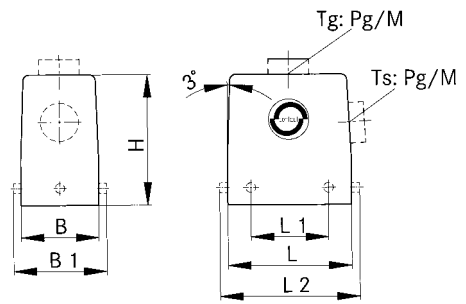

EPIC® H-B Gehäuse: Tüllengehäuse (Kabeleingang seitlich, Bolzen für Querbügel)

EPIC® H-B housings: hood (side entry, bolts for double locking lever)

Boîtiers EPIC® H-B: capot (sortie latérale, ergots pour double levier)

H-B 32

Artikel part article	Art.Nr. part No. N° art.	PG	M	ZW	L	L1	L2	L3	L4	B	B1	B2	B3	B4	B5	H	H1	H2	S	d
H-B 32 TS 21	10135000	21		●																
H-B 32 TS 29	10136000	29		●	93,5	64,5				79	89,5					95				
H-B 32 TS 29	10135600	29																		
H-B 32 TS M25	19135000		25																	
H-B 32 TS M32	19136000		32		93,5	64,5				79	89,5					95				
H-B 32 TS M40	19136200		40																	

Einsätze / Inserts / Inserts: 1.4: H-BE 32 / 1.5: H-EE 64 / 1.6: H-BS 12 / 1.8: H-D 80 / 1.9: H-DD 144 / 1.10: 2 x MC 16

Kabelverschraubung / Cable gland / Presse-étoupe: 5.1: Metr. / 5.2: PG / 5.3: Kit